

parxis®



“otopark güvenligi”

2026 Ürün Katalođu

Otopark Ekipmanları

[www.parxis.com.tr](http://www.parxis.com.tr)

Araç ve yaya trafiğini düzene sokarak  
modern şehirciliğin en kritik ihtiyacı  
olan maksimum güvenliği  
standart haline getirmeyi  
amaçlıyoruz.



## /Misyonumuz/



### İNNOVASYON VE MÜHENDİSLİK

*Mühendislik yeteneklerimizi modern tasarım estetiğiyle birleştirerek, otopark yönetiminde karmaşayı ortadan kaldıran akılcı çözümler sunuyoruz. Misyonumuz; uluslararası standartlardaki ekipman portföyümüzle otoparkları daha güvenli ve kullanıcı deneyimini daha konforlu hale getiren bir altyapı mimarı olmaktır.*





















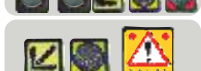
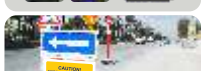

### ÇÖZÜM ORTAKLIĞI

*İş ortaklarımızın projelerine değer katmak yönlendirmeden korumaya, sınırlandırmadan uyarı sistemlerine kadar ürettiğimiz her parça; can ve mal güvenliğini koruma sorumluluğumuzun bir yansımasıdır.*

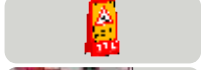

# / İndeks /

	Araç Otopark Stoperleri	06
	Kilitli ve Kumandalı Otopark Bariyerleri	06
	Otopark Kasis Kapanı	06
	Otopark Kolon Köşe Koruyucular	07
	Trafik Güvenlik Aynaları	07
	Solar Yol İşaretleme Butonları	08
	Merceklı Yol Butonları	08
	Cam Kedi Gözlü ve Merceklı Yol Butonları	08
	Kauçuk Şaseli Yol Kasisleri	09
	PPC Merceklı Yol Kasisleri	09
	PPC Solar Flaşörlü ve Kedi Gözlü Yol Kasisleri	09
	TPU - Esnek Delinatörler	10
	TPE - Esnek Delinatörler (Soketli)	11
	Delinatörlü Şerit Düzenleme Butonları	12
	Kedi Gözlü / Levhalı Şerit Düzenleme Butonları	12
	Levhalı Şerit Düzenleme Butonları	13
	Solar Flaşörlü / Cam Reflektörlü Şerit Sınırlama Butonları	13
	TPU - Esnek Refüj Başı Levhaları	14
	TPU - Demonte & Levhalı Esnek Delinatörler	14
	TPU - Esnek Delinatörler (Soketli)	14
	TPE / PPC Kedi Gözlü Koniler / Katlanır Reklam Levhası	15
	Levhalı Reklam Dubaları ve Portatif Uyarı Levhaları	15
	90 / 75 / 50 cm PVC / TPE Trafik Konileri	16
	70 / 52 cm PVC / TPE Trafik Konileri	17
	90 / 50 / 32 cm PVC - 32 cm TPE Trafik Konisi	17
	Solar Flaşörlü LED'li Lambalar	18

	Çakar Flaşörlü Solar ve Bataryalı Lambalar	18
	Dubalı Uyarı Dikmeleri	19
	Kablo ve Hortum Koruyucu Kasisler	20
	Görme Engelli Zemin İşaretlemeleri ve TPU Merdiven Kaydırmaz Kaplama	21
	Demonte Kaldırım Sınırlama Dubaları	22
	Levhalı Esnek Refüj Dubaları	22
	Kaldırım Sınırlama Dubaları	23
	Anti-Park Dubaları - Metal	23
	Solar LED'li Yol Bakım Levhaları	24
	Solar LED'li Uyarı Levhaları	24
	Güvenlik Barikatları	25
	Levhalı Güvenlik Barikatları	25
	Dubalı Uyarı Levhalı Bariyerler	26
	Solar LED'li Flaşör Uyarı Lambaları ve Uyarı Levhaları	27
	AC LED'li Lambalar ve Yol Bakım Levhaları	27
	Katlanır Uyarı Levhalı Bariyerler	28
	Solar LED'li Yol Bakım Levhaları	29
	Güvenlik Bariyerleri (Kedi Gözlü / Solar)	30
	Güvenlik Bariyerleri (Delinatörlü / Levhalı)	30
	Metal Güvenlik Barikadı	30
	Levhalı Uyarı Dubaları ve Katlanır Uyarı Levhalı Bariyer	31
	Katlanır ve Otoyol Uyarı Levhaları	31
	Plastik Uyarı Levhaları	32
	Reflektif Bantlar	32
	Ürün Montaj Adaptörleri / Plastik Zincirler	33
	Vida / Dübel / Çivi	33



## Araç Otopark Stoperleri

ÜRÜN KODU	AÇIKLAMALAR
12231 UB	araç otopark stoperi - (HxL) 10x180 cm malzeme: PPC / ağırlık: 6.8 kg / montaj: 5x
12233 UB	araç otopark stoperi- (HxL) 10x110 cm malzeme: PPC / ağırlık: 4.3 kg / montaj: 3x
12235 UB	araç otopark stoperi - (HxL) 10x55 cm malzeme: PPC / ağırlık: 1.9 kg / montaj: 2x
22231 UB R	reflektif bantlı araç otopark stoperi - (HxL) 8.5x180 cm malzeme: PPC / ağırlık: 4.3 kg / montaj: 5x
12216 UB R	reflektif bantlı otopark araç stoperi - (HxL) 10x50 cm malzeme: PVC / ağırlık: 2.4 kg / montaj: 3x



## Kilitli ve Kumandalı Otopark Bariyerleri

ÜRÜN KODU	AÇIKLAMALAR
22210 UB ST	kilitli otopark bariyeri - (HxW) 50x38 cm malzeme: PPC-ST / ağırlık: 5.40 kg / montaj: 3x
22212 UB ST	kumandalı pilli otopark bariyeri - (HxW) 45x40 cm malzeme: ST / ağırlık: 5.45 kg / montaj: 3x
22213 UB ST	kumandalı solar otopark bariyeri - (HxW) 45x40 cm malzeme: ST / ağırlık: 5.45 kg / montaj: 3x

- Park yeri zeminine kapak altındaki vida yerinden sabitlenir.
- Güneş ve pil enerji devresi
- "No Parking" logosu bulunan oval şekilli gövde
- Her bariyer için iki uzaktan kumanda ve iki anahtar
- Yetkisiz manuel açma girişiminde bulunulması durumunda alarm sensörü devreye girer.



## Otopark Kasis Kapanı

ÜRÜN KODU	AÇIKLAMALAR
12290 UB	otopark kasis kapanı - ölçü: 6.0x50x50 cm malzeme: PPC-ST / ağırlık: 7.3 kg / montaj: 6x
12291 UB K	otopark kasis kapan kapağı - ölçü: 6.0x50x9.0 cm malzeme: PPC / ağırlık: 0.70 kg / montaj: 2x

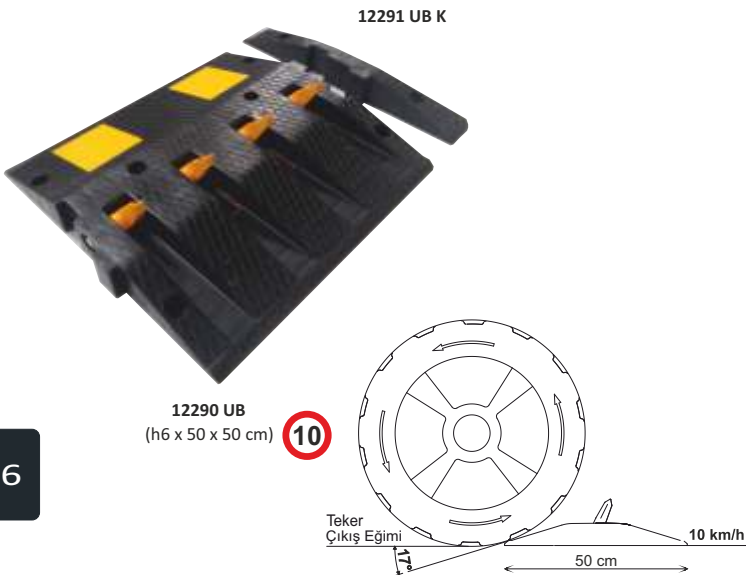



## Otopark Kolon Köşe Koruyucular

Prismatic Reflective Sheeting

ÜRÜN KODU	AÇIKLAMALAR
12292 UB R	otopark kolon köşe koruyucu - (H) 90 cm malzeme: PVC / ağırlık: 1.9 kg / montaj: 6x
12295 UB R	otopark kolon köşe koruyucu - (H) 80 cm malzeme: PVC / ağırlık: 2.0 kg / montaj: 6x
12294 UB R	otopark kolon köşe koruyucu - (H) 80 cm malzeme: PVC / ağırlık: 1.9 kg / montaj: 6x
12296 UB R	otopark kolon köşe koruyucu - (H) 80 cm malzeme: PVC / ağırlık: 1.9 kg / montaj: 6x



12292 UB R



12295 UB R



12294 UB R



12296 UB R

## Trafik Güvenlik Aynaları

ÜRÜN KODU	AÇIKLAMALAR
12226 TG A	trafik güvenlik aynası - ölçü: (Ø) 800 mm malzeme: PPC / ağırlık: 5.5 kg
12227 TG A	trafik güvenlik aynası - ölçü: (Ø) 800 mm malzeme: PPC / ağırlık: 5.5 kg
12228 TG A	trafik güvenlik aynası - ölçü: (Ø) 600 mm malzeme: PPC / ağırlık: 3.8 kg
12229 TG A	trafik güvenlik aynası - ölçü: (Ø) 600 mm malzeme: PPC / ağırlık: 3.8 kg
12248 TG A	trafik güvenlik aynası - ölçü: 60x80 cm malzeme: ABS / ağırlık: 6.0 kg
12246 TG A	trafik güvenlik aynası - ölçü: 60x80 cm malzeme: ABS / ağırlık: 6.0 kg
12267 TG A	trafik güvenlik aynası - ölçü: 40x60 cm malzeme: ABS / ağırlık: 3.3 kg
12265 TG A	trafik güvenlik aynası - ölçü: 40x60 cm malzeme: ABS / ağırlık: 3.3 kg



12226 TG A



12227 TG A



12228 TG A



12229 TG A



12248 TG A



12246 TG A



12267 TG A



12265 TG A

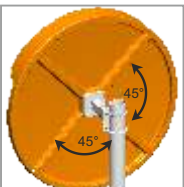



11924 SL K



11926 SL S



11920 SL K



11922 SL S



11921 SL K



11923 SL S

## Solar Yol İşaretleme Butonları

ÜRÜN KODU	AÇIKLAMALAR
 11924 SL K	solar yol işaretleme butonu - 145x125x28 mm malzeme: AL / ağırlık: 0.48 kg / montaj: epoksi
 11926 SL S	solar yol işaretleme butonu - 145x125x28 mm malzeme: AL / ağırlık: 0.48 kg / montaj: epoksi
 11920 SL K	solar yol işaretleme butonu - 145x125x28 mm malzeme: AL / ağırlık: 0.45 kg / montaj: 2x
 11922 SL S	solar yol işaretleme butonu - 145x125x28 mm malzeme: AL / ağırlık: 0.45 kg / montaj: 2x
 11921 SL K	solar yol işaretleme butonu - 135x120x28 mm malzeme: AL / ağırlık: 0.57 kg / montaj: 2x
 11923 SL S	solar yol işaretleme butonu - 135x120x28 mm malzeme: AL / ağırlık: 0.57 kg / montaj: 2x

### ELEKTRONİK DEVRE TEKNİK ÖZELLİKLERİ

	tip	monocrystalline silicon cell	LED	renk	şarj kırmızı
solar panel	ölçü (H/L)	60*54mm		ölçü	Ø 5 mm led
	voltaj	3V		flaş sayısı	115 f/dk
	watt	0.4 W		uyarı mesafesi	100 m(gece)
	malzeme	Ni-MH		çalışma süresi	gün ışığında şarj ile tüm gece
şarjlı pil	voltaj	1.2 V		çalışma sıcaklığı	-20°C/+60°C
	akım	2000 mA/h			

## Mercekli Yol Butonları

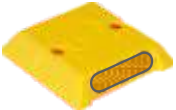

12005-2 YB



12005 YB



12000 YB







12006 YB



12002 YB



12003 YB

ÜRÜN KODU	AÇIKLAMALAR
 12005-2 YB	merceklı yol butonu - 100x100x21 mm malzeme: ABS / ağırlık: 0.15 kg / montaj: 2x
 12005 YB	merceklı yol butonu - 105x105x20 mm malzeme: ABS / ağırlık: 0.12 kg / montaj: 2x
 12000 YB	merceklı yol butonu - 125x150x32 mm malzeme: PPC / ağırlık: 0.20 kg / montaj: 4x
 12006 YB	merceklı yol butonu - 120x220x28 mm malzeme: PPC / ağırlık: 0.22 kg / montaj: 2x
 12002 YB	merceklı yol butonu - 120x120x28 mm malzeme: PPC / ağırlık: 0.18 kg / montaj: 4x
 12003 YB	merceklı yol butonu - 100x220x32 mm malzeme: PPC / ağırlık: 0.24 kg / montaj: 4x

## Cam Kedi Gözlü ve Merceklı Yol Butonları



12011 YB



12007 YB



12009 YB



12004 YB



12123 YK



12124 YK

ÜRÜN KODU	AÇIKLAMALAR
 12011 YB	cam kedi gözlü yol butonu - 100x102x21 mm malzeme: AL / ağırlık: 0.40 kg / montaj: epoksi
 12007 YB	cam kedi gözlü yol butonu - 120x120x28 mm malzeme: AL / ağırlık: 0.30 kg / montaj: 2x
 12009 YB	cam kedi gözlü yol butonu - 100x100x21 mm malzeme: ABS / ağırlık: 0.15 kg / montaj: 2x
 12004 YB	merceklı yol butonu - 140x120x25 cm malzeme: PPC / ağırlık: 0.12 kg / montaj: 4x
 12123 YK	merceklı yol butonu - (Ø) 250x35 mm malzeme: PPC / ağırlık: 0.45 kg / montaj: 4x
 12124 YK	merceklı yol butonu - (Ø) 250x35 mm malzeme: PPC / ağırlık: 0.45 kg / montaj: 4x



## Kauçuk Şaseli Yol Kasisleri

ÜRÜN KODU	AÇIKLAMALAR
12108 YK	kauçuk şaseli yol kasisi - ölçü: 4.5x60x50 cm malzeme: PVC-PPC / ağırlık: 9.3 kg / montaj: 4x
12116 YK	kauçuk şaseli yol kasisi - ölçü: 4.5x60x50 cm malzeme: PVC-PPC / ağırlık: 9.3 kg / montaj: 6x
12109 YK K	kauçuk şaseli yol kasis kapağı - ölçü: 4.5x60x30 cm malzeme: PVC-PPC / ağırlık: 3.4 kg / montaj: 2x
12110 YK	kauçuk şaseli yol kasisi - ölçü: 4x40x50 cm malzeme: PVC-PPC / ağırlık: 6.5 kg / montaj: 4x
12111 YK K	kauçuk şaseli yol kasis kapağı - ölçü: 4.0x40x20 cm malzeme: PVC-PPC / ağırlık: 1.7 kg / montaj: 2x
12106 YK	kauçuk şaseli yol kasisi - ölçü: 4.0x40x50 cm malzeme: PVC-PPC / ağırlık: 6.5 kg / montaj: 4x
12107 YK K	kauçuk şaseli yol kasis kapağı - ölçü: 4.0x40x20 cm malzeme: PVC-PPC / ağırlık: 1.7 kg / montaj: 2x



12108 YK  
(h4.5 x 60 x 50 cm) 40

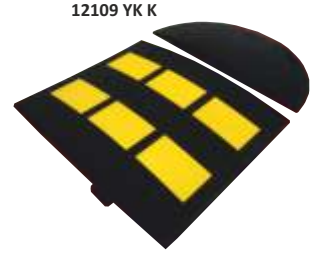

12116 YK  
(h4.5 x 60 x 50 cm) 40



12110 YK  
(h4 x 40 x 50 cm) 30

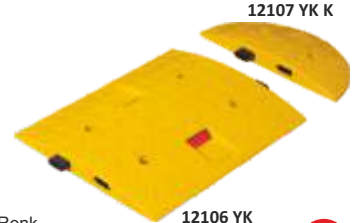

12106 YK  
(h4 x 40 x 50 cm) 30



## PPC Merceklı Yol Kasisleri

ÜRÜN KODU	AÇIKLAMALAR
12102 YK	merceklı yol kasisi - ölçü: 4.0x30x33.5 cm malzeme: PPC / ağırlık: 1.35 kg / montaj: 4x
12103 YK K	merceklı yol kasis kapağı - ölçü: 4.0x30x10 cm malzeme: PPC / ağırlık: 0.25 kg / montaj: 2x
12120 YK	merceklı yol kasisi - ölçü: 3.5x25x50 cm malzeme: PPC / ağırlık: 1.15 kg / montaj: 4x
12121 YK K	merceklı yol kasis kapağı - ölçü: 3.5x25x12 cm malzeme: PPC / ağırlık: 0.26 kg / montaj: 2x
12100 YK	merceklı yol kasisi - ölçü: 5.0x25x34.5 cm malzeme: PPC / ağırlık: 1.5 kg / montaj: 4x
12101 YK K	merceklı yol kasis kapağı - ölçü: 5.0x25x10 cm malzeme: PPC / ağırlık: 0.35 kg / montaj: 2x

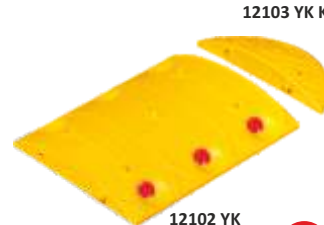

12102 YK  
(h4 x 30 x 33.5 cm) 20

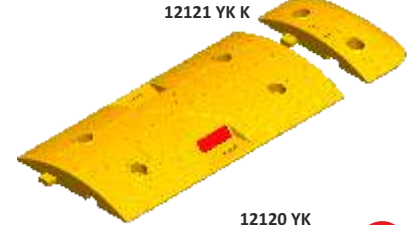

12120 YK  
(h3.5 x 25 x 50 cm) 20



12100 YK  
(h5 x 25 x 34.5 cm) 10



## PPC Solar Flaşörlü ve Kedi Gözllü Yol Kasisleri

ÜRÜN KODU	AÇIKLAMALAR
11938 SL	solar flaşörlü yol kasisi - ölçü: 4.5x50x50 cm malzeme: PPC / ağırlık: 3.1 kg / montaj: 4x
11940 SL K	solar flaşörlü yol kasis kapağı - ölçü: 4.5x50x25 cm malzeme: PPC / ağırlık: 1.1 kg / montaj: 2x
12112 YK	kedi gözllü yol kasisi - ölçü: 4.5x50x50 cm malzeme: PPC / ağırlık: 3.1 kg / montaj: 4x
12113 YK K	kedi gözllü yol kasis kapağı - ölçü: 4.5x50x25 cm malzeme: PPC / ağırlık: 1.1 kg / montaj: 2x

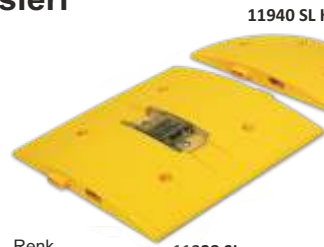

11938 SL  
(h4.5 x 50 x 50 cm) 30

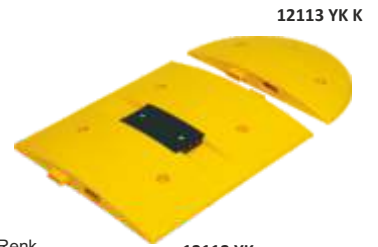

12112 YK  
(h4.5 x 50 x 50 cm) 30



### 11938 SL - ELEKTRONİK DEVRE TEKNİK ÖZELLİKLERİ

tip	ölçü (H/L)	voltaj	watt	malzeme	tip	ölçü	flaş sayısı	uyarı mesafesi	çalışma süresi	çalışma sıcaklığı
solar panel	monocrystalline silicon cell 60*54mm	3V	0.4 W	Ni-MH	LED	Ø 5 mm led	115 f/dk	100 m(gece)	gün ışığında şarj ile tüm gece	-20°C/+60°C
şarjlı pil		1.2 V								



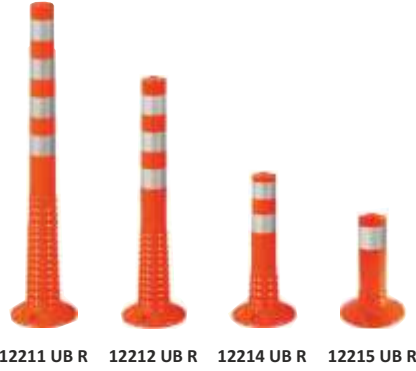

12211 UB R 12212 UB R 12214 UB R 12215 UB R



OPSİYONEL AKSESUARLAR



**TPU - Esnek Delinatörler**  
Reflective High Intensity Grade

	ÜRÜN KODU	AÇIKLAMALAR
	12211 UB R	TPU esnek delinatör - (HxØ) 100 cm x 80 mm taban: (Ø) 200 mm / montaj: 3x / ağırlık: 1.60 kg
	12212 UB R	TPU esnek delinatör - (HxØ) 75 cm x 80 mm taban: (Ø) 200 mm / montaj: 3x / ağırlık: 1.30 kg
	12214 UB R	TPU esnek delinatör - (HxØ) 45 cm x 80 mm taban: (Ø) 200 mm / montaj: 3x / ağırlık: 0.98 kg
	12215 UB R	TPU esnek delinatör - (HxØ) 30 cm x 80 mm taban: (Ø) 200 mm / montaj: 3x / ağırlık: 0.72 kg



**TPU - Esnek Delinatörler**  
Reflective High Intensity Grade

	ÜRÜN KODU	AÇIKLAMALAR
	12288 UB R	TPU esnek delinatör - (HxØ) 100 cm x 80 mm taban: (Ø) 200 mm / montaj: 3x / ağırlık: 1.60 kg
	12286 UB R	TPU esnek delinatör - (HxØ) 75cm x 80 mm taban: (Ø) 200 mm / montaj: 3x / ağırlık: 1.30 kg
	12284 UB R	TPU esnek delinatör - (HxØ) 45 cm x 80 mm taban: (Ø) 200 mm / montaj: 3x / ağırlık: 0.98 kg
	12282 UB R	TPU esnek delinatör - (HxØ) 30 cm x 80 mm taban: (Ø) 200 mm / montaj: 3x / ağırlık: 0.72 kg
	12245 UB R	TPU esnek delinatör - (HxØ) 30 cm x 80 mm taban: (Ø) 200 mm / montaj: 3x / ağırlık: 0.72 kg
	12244 UB R	TPU esnek delinatör - (HxØ) 45 cm x 80 mm taban: (Ø) 200 mm / montaj: 3x / ağırlık: 0.98 kg
	12242 UB R	TPU esnek delinatör - (HxØ) 75 cm x 80 mm taban: (Ø) 200 mm / montaj: 3x / ağırlık: 1.30 kg
	12241 UB R	TPU esnek delinatör - (HxØ) 100 cm x 80 mm taban: (Ø) 200 mm / montaj: 3x / ağırlık: 1.60 kg



**TPU - Esnek Delinatörler**  
Reflective High Intensity Grade

	ÜRÜN KODU	AÇIKLAMALAR
	22036 UB R	TPU esnek delinatör - (HxØ) 100 cm x 80 mm taban: (Ø) 200 mm / montaj: 3x / ağırlık: 1.60 kg
	22037 UB R	TPU esnek delinatör - (HxØ) 75 cm x 80 mm taban: (Ø) 200 mm / montaj: 3x / ağırlık: 1.30 kg
	22038 UB R	TPU esnek delinatör - (HxØ) 45 cm x 80 mm taban: (Ø) 200 mm / montaj: 3x / ağırlık: 0.98 kg
	22039 UB R	TPU esnek delinatör - (HxØ) 30 cm x 80 mm taban: (Ø) 200 mm / montaj: 3x / ağırlık: 0.72 kg





## TPE - Esnek Delinatörler(Soketli)

Reflective High Intensity Grade

ÜRÜN KODU	AÇIKLAMALAR
22040 UB R	TPE esnek delinatör(soketli) - (HxØ)100cmx80mm taban: (Ø) 200 mm / montaj: 3x / ağırlık: 0.94 kg
22042 UB R	TPE esnek delinatör(soketli) - (HxØ) 75cmx80mm taban: (Ø) 200 mm / montaj: 3x / ağırlık: 0.73 kg
22044 UB R	TPE esnek delinatör(soketli) - (HxØ) 45cmx80mm taban: (Ø) 200 mm / montaj: 3x / ağırlık: 0.49 kg
12275 UB R	TPE esnek delinatör - (HxØ) 30cmx80mm taban: (Ø) 200 mm / montaj: 3x / ağırlık: 0.53 kg
12274 UB R	TPE esnek delinatör(soketli) - (HxØ)40cmx80mm taban: (Ø) 180 mm / montaj: 3x / ağırlık: 0.52 kg
12272 UB R	TPE esnek delinatör(soketli) - (HxØ)70cmx80mm taban: (Ø) 180 mm / montaj: 3x / ağırlık: 0.74 kg



### OPSİYONEL AKSESUARLAR



129 A



128 A



127 A



174 A



196 A



11819 FL S



11814 FL S

## TPE - Esnek Delinatörler(Soketli)

Reflective High Intensity Grade

ÜRÜN KODU	AÇIKLAMALAR
22048 UB R	TPE esnek delinatör(soketli) - (HxØ)100cmx80mm taban: (Ø) 200 mm / montaj: 3x / ağırlık: 0.94 kg
22050 UB R	TPE esnek delinatör(soketli) - (HxØ)75cmx80mm taban: (Ø) 200 mm / montaj: 3x / ağırlık: 0.73 kg
22052 UB R	TPE esnek delinatör(soketli) - (HxØ)45cmx80mm taban: (Ø) 200 mm / montaj: 3x / ağırlık: 0.49 kg
22019 UB R	TPE esnek delinatör - (HxØ)30cmx80mm taban: (Ø) 200 mm / montaj: 3x / ağırlık: 0.53 kg
22029 UB R	TPE esnek delinatör - (HxØ)30cmx80mm taban: (Ø) 200 mm / montaj: 3x / ağırlık: 0.53 kg
22053 UB R	TPE esnek delinatör(soketli) - (HxØ)45cmx80mm taban: (Ø) 200 mm / montaj: 3x / ağırlık: 0.49 kg
22051 UB R	TPE esnek delinatör(soketli) - (HxØ)75cmx80 mm taban: (Ø) 200 mm / montaj: 3x / ağırlık: 0.73 kg
22049 UB R	TPE esnek delinatör(soketli) - (HxØ)100cmx80mm taban: (Ø) 200 mm / montaj: 3x / ağırlık: 0.94 kg



## TPE - Esnek Delinatörler

Reflective High Intensity Grade

ÜRÜN KODU	AÇIKLAMALAR
22059 UB R	TPE esnek delinatör - (HxØ)30cmx80mm taban: (Ø) 200 mm / montaj: 3x / ağırlık: 0.53 kg
22058 UB R	TPE esnek delinatör(soketli) - (HxØ)45cmx80mm taban: (Ø) 200 mm / montaj: 3x / ağırlık: 0.49 kg
22057 UB R	TPE esnek delinatör(soketli) - (HxØ)75cmx80mm taban: (Ø) 200 mm / montaj: 3x / ağırlık: 0.73 kg
22056 UB R	TPE esnek delinatör(soketli) - (HxØ)100cmx80mm taban: (Ø) 200 mm / montaj: 3x / ağırlık: 0.94 kg
22021 UB R	TPE S esnek delinatör - (HxØ) 100cmx80mm taban: (Ø) 200 mm / montaj: 3x / ağırlık: 1.2 kg
22022 UB R	TPE S esnek delinatör - (HxØ) 75cmx80mm taban: (Ø) 200 mm / montaj: 3x / ağırlık: 0.95 kg
22023 UB R	TPE S esnek delinatör - (HxØ) 45cmx80mm taban: (Ø) 200 mm / montaj: 3x / ağırlık: 0.73 kg
22024 UB R	TPE S esnek delinatör - (HxØ) 30cmx80mm taban: (Ø) 200 mm / montaj: 3x / ağırlık: 0.53 kg





12251 UB R

12268 UB R

12270 UB R

## Delinatörlü Şerit Düzenleme Butonları

Reflective High Intensity Grade

	ÜRÜN KODU	AÇIKLAMALAR
	12251 UB R	delinatörlü şerit düzenleme butonu-(HxLxW)92x100x22cm montaj: 6x / malzeme:PPC-TPU / ağırlık: 4.6 kg
	12268 UB R	delinatörlü şerit düzenleme butonu-(HxLxW)75x100x22cm montaj: 6x / malzeme:PPC-TPU / ağırlık: 4.2 kg
	12270 UB R	delinatörlü şerit düzenleme butonu-(HxLxW)45x100x22cm montaj: 6x / malzeme:PPC-TPU / ağırlık: 3.8 kg



12297 UB R

12219 UB R

12218 UB R

## Delinatörlü Şerit Düzenleme Butonları

Reflective High Intensity Grade

	ÜRÜN KODU	AÇIKLAMALAR
	12297 UB R	delinatörlü şerit düzenleme butonu-(HxLxW)92x100x20cm montaj: 4x / malzeme: PPC-TPU / ağırlık: 4.8 kg
	12219 UB R	delinatörlü şerit düzenleme butonu-(HxLxW)75x100x20cm montaj: 4x / malzeme: PPC-TPU / ağırlık: 4.5 kg
	12218 UB R	delinatörlü şerit düzenleme butonu-(HxLxW)45x100x20cm montaj: 4x / malzeme: PPC-TPU / ağırlık: 4.1 kg



### OPSİYONEL AKSESUARLAR

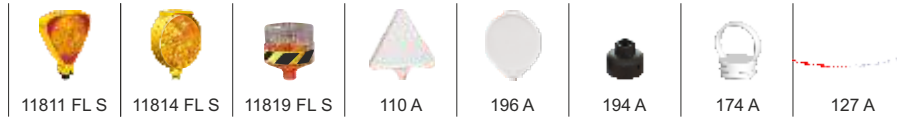

## Kedi Gözlü / Levhalı Şerit Düzenleme Butonları

	ÜRÜN KODU	AÇIKLAMALAR
	12262 UB	kedi gözlü şerit sınırlama butonu-(HxLxW)7.5x100x22cm montaj: 6x / malzeme: PPC / ağırlık: 3.5 kg
	12266 UB R	levhalı şerit düzenleme butonu - (HxLxW) 66x100x22 cm montaj: 6x / malzeme: PPC / ağırlık: 3.6 kg
	12260 UB R	şerit sınırlama butonu - (HxLxW) 6.0x100x15 cm montaj: 3x / malzeme: PVC / ağırlık: 6.0 kg

Reflektif Ölçüsü: 57.5x13 cm - Prismatic Reflective Sheeting



Şekil 1 Şekil 2 Şekil 3 Şekil 4 Şekil 5  
Opsiyonel Uyarı İşaretleri (Tek Yönlü)

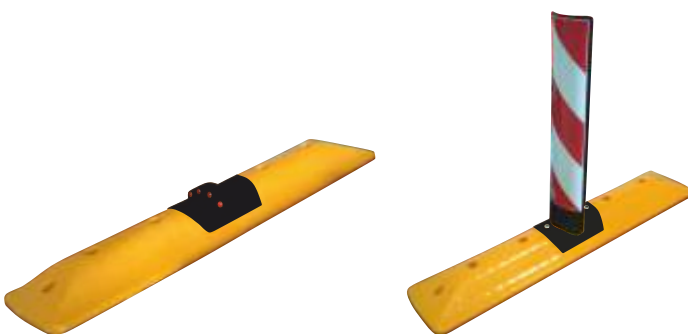

12262 UB

12266 UB R

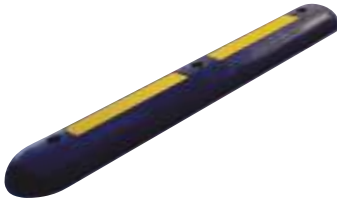

12260 UB R

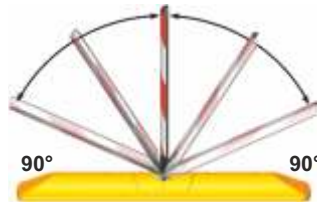

Esnek Levha



## Levhali Şerit Düzenleme Butonları

Prismatic Reflective Sheeting

ÜRÜN KODU	AÇIKLAMALAR
22203 UB R	levhali şerit düzenleme butonu - (HxLxW) 29x18x12 cm montaj: 2x / malzeme: ABS-TPU / ağırlık: 0.62 kg
22202 UB R	levhali şerit düzenleme butonu - (HxLxW) 60x18x12 cm montaj: 2x / malzeme: ABS-TPU / ağırlık: 0.86 kg
22206 DB R	levhali şerit düzenleme butonu - (HxLxW) 74x30x25cm reflektif:48x20cm/montaj:2x/malzeme:PPC/ağırlık:2.48kg
22205 DB R	levhali şerit düzenleme butonu - (HxLxW) 102.5x30x25cm reflektif:80x20cm/montaj:2x/malzeme:PPC/ağırlık:2.85kg



### Ürün Özellikleri

22203 UB R - 22202 UB R - 22206 DB R  
➤ Çarpmalara karşı esneme özelliği

22205 DB R  
➤ Çarpmalara karşı katlanma özelliği

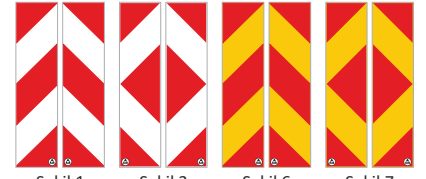

Şekil 1 Şekil 3 Şekil 6 Şekil 7  
Opsiyonel Uyarı İşaretleri (İki Yönlü)

## Levhali Şerit Düzenleme Butonları

Prismatic Reflective Sheeting

ÜRÜN KODU	AÇIKLAMALAR
12206 UB R	levhali şerit düzenleme butonu - (HxLxW) 60x26x16 cm montaj: 2x / malzeme: PPC-TPU / ağırlık: 0.90 kg
12207 UB R	levhali şerit düzenleme butonu - (HxLxW) 30x26x16 cm montaj: 2x / malzeme: PPC-TPU / ağırlık: 0.75 kg
12204 UB R	levhali şerit düzenleme butonu - (HxLxW) 60x118x15 cm montaj: 3x / malzeme: PPC-TPU / ağırlık: 2.7 kg
12203 UB R	levhali şerit düzenleme butonu - (HxLxW) 30x118x15 cm montaj: 3x / malzeme: PPC-TPU / ağırlık: 2.5 kg

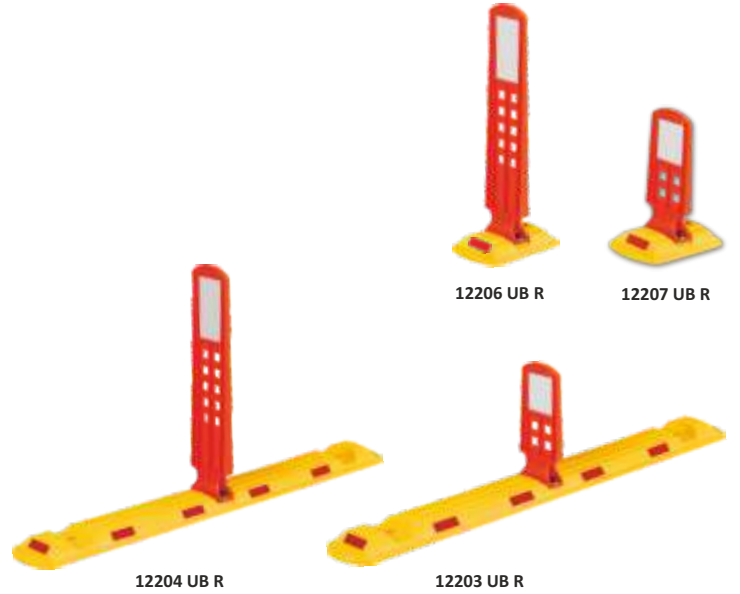

## Solar Flaşörlü / Cam Reflektörlü Şerit Sınırlama Butonları

ÜRÜN KODU	AÇIKLAMALAR
12202 UB	şerit sınırlama butonu - (HxLxW) 4.8x118x15 cm montaj: 3x / malzeme: PPC / ağırlık: 2.3 kg
12220 UB	solar flaşörlü şerit sınırlama butonu-(HxLxW)8.0x100x20cm montaj: 4x / malzeme: PPC / ağırlık: 3.7 kg
12217 UB	cam reflektörlü şerit sınırlama butonu-(HxLxW)8.0x100x20cm montaj: 4x / malzeme: PPC / ağırlık: 4.1 kg

### 12220 UB - ELEKTRONİK DEVRE TEKNİK ÖZELLİKLERİ

solar panel	tip	monocrystalline silicon cell	LED	renk	sarı kırmızı
	ölçü (H/L)	60*54mm		ölçü	Ø 5 mm led
	voltaj	3V		flaş sayısı	115 f/dk
	watt	0.4 W		uyarı mesafesi	100 m(gece)
şarjlı pil	malzeme	Ni-MH	çalışma süresi	gün ışığında şarj ile tüm gece	
	voltaj	1.2 V	çalışma sıcaklığı	-20°C/+60°C	
	akım	2000 mA/h			





Opsiyonel Uyarı İşaretleri  
(Tek Yönlü)

## TPU - Esnek Refüj Başı Levhaları

Prismatic Reflective Sheeting

ÜRÜN KODU	AÇIKLAMALAR
12250 UB R	esnek refüj başı levhası - (HxØ) 100cmx300mm(reflektif) montaj:4x / malzeme:TPU / ağırlık:3.25 kg-(siyah gövde)
12252 UB R	esnek refüj başı levhası - (HxØ) 100cmx300mm(reflektif) montaj:4x / malzeme:TPU / ağırlık:3.25 kg-(turuncu gövde)
12254 UB R	esnek refüj başı levhası - (HxØ) 90cmx200mm(reflektif) montaj: 4x / malzeme: TPU / ağırlık: 2.00 kg
12253 UB R	esnek refüj başı levhası - (HxØ) 75cmx100mm(reflektif) montaj: 4x / malzeme: TPU / ağırlık: 1.40 kg
22067 UB R	esnek refüj başı levhası - (HxØ) 45cmx100 mm(reflektif) montaj: 4x / malzeme: TPU / ağırlık: 0.95 kg

\*\* Bu Ürünlerde Farklı Şekil Baskı Seçeneği



## TPU - Demonte & Levhalı Esnek Delinatörler

Reflective High Intensity Grade

ÜRÜN KODU	AÇIKLAMALAR
12278 UB R	demonte esnek delinatörler - (HxØ) 92 cm x 80 mm taban: (Ø) 200 mm / montaj: epoksi / ağırlık: 1.75 kg
12232 UB R	demonte esnek delinatörler - (HxØ) 75cm x 80mm taban: (Ø) 200 mm / montaj: epoksi / ağırlık: 1.48 kg
12236 UB R	demonte esnek delinatörler - (HxØ) 45 cm x 80 mm taban: (Ø) 200 mm / montaj: epoksi / ağırlık: 1.1 kg
22008 UB R	demonte esnek delinatörler - (HxØ) 92 cm x 80 mm taban: (Ø) 120 mm / montaj: 1x / ağırlık: 1.65 kg
22068 UB R	levhalı esnek delinatör - (HxL)45x12 cm/taban:(Ø)200 mm montaj: 4x / malzeme: TPU / ağırlık: 0.95 kg
12256 UB R	levhalı esnek delinatör - (HxL)75x12 cm/taban:(Ø)200 mm montaj: 4x / malzeme: TPU / ağırlık: 1.4 kg



### OPSİYONEL AKSESUARLAR



## TPU - Esnek Delinatörler(Soketli)

Reflective High Intensity Grade

ÜRÜN KODU	AÇIKLAMALAR
12237 UB R	TPU esnek delinatörler(soketli)-(HxØ)75cmx110mm taban: (Ø) 260 mm / montaj: 4x / ağırlık: 2.1 kg
12249 UB R	TPU esnek delinatörler(soketli)-(HxØ)100cmx100mm taban: (Ø) 200 mm / montaj: 3x / ağırlık: 2.0 kg
12243 UB R	TPU esnek delinatörler(soketli)-(HxØ)75cmx90mm taban: (Ø) 200 mm / montaj: 3x / ağırlık: 1.5 kg
12247 UB R	TPU esnek delinatörler(soketli)-(HxØ)50cmx80mm taban: (Ø) 200 mm / montaj: 3x / ağırlık: 1.0 kg
12281 UB R	TPU esnek delinatörler(soketli)-(HxØ)70cmx80mm taban: (Ø) 180 mm / montaj: 3x / ağırlık: 1.0 kg
12283 UB R	TPU esnek delinatörler(soketli)-(HxØ)40cmx80mm taban: (Ø) 180 mm / montaj: 3x / ağırlık: 0.70 kg



### OPSİYONEL AKSESUARLAR





## TPE / PPC Kedi Gözlü Koniler ve Katlanır Reklam Levhası

ÜRÜN KODU	AÇIKLAMALAR
12386 TK R2	TPE trafik konisi - (H) 75 cm taban:(∅) 38.5 cm / malzeme: TPE / ağırlık: 2.7 kg
12388 TK A R2	TPE trafik konisi - (H) 75 cm taban:(∅) 48.5 cm / malzeme: TPE / ağırlık: 6.0 kg
12300 TK	klasik kedi gözlü koni - (H) 50 cm taban:(∅) 35 cm / malzeme: PPC / ağırlık: 1.2 kg
12301 TK A	klasik kedi gözlü koni - (H) 52 cm taban:(∅) 35 cm / malzeme: PPC / ağırlık: 4.0 kg
12302 TK	eko trafik konisi - (H) 50 cm taban:(∅) 35 cm / malzeme: PPC / ağırlık: 0.90 kg
12350 TK	ultra kedi gözlü koni - (H) 60 cm taban:(∅) 37 cm / malzeme: PPC / ağırlık: 1.4 kg
12351 TK A	ultra kedi gözlü koni - (H) 62 cm taban:(∅) 37 cm / malzeme: PPC / ağırlık: 5.0 kg
12352 TK A	ultra kedi gözlü koni - (H) 62 cm taban:(∅) 37 cm / malzeme: PPC / ağırlık: 5.0 kg
12353 TK A	ultra kedi gözlü koni - (H) 62 cm taban:(∅) 37 cm / malzeme: PPC / ağırlık: 5.0 kg
12354 TK A	ultra kedi gözlü koni - (H) 62 cm taban:(∅) 37 cm / malzeme: PPC / ağırlık: 5.0 kg
12431 DB	katlanır reklam levhası - (HxW) 90x60 cm malzeme: PPC / levha dekota: 60x60cm / ağırlık:12.0kg



12431 DB  
Bu Ürüne Özel Baskı Uygulanabilir



Şekil 1



Şekil 2



Şekil 3



Şekil 4

Opsiyonel Uyarı İşaretleri (Tek Yönlü)

OPSİYONEL AKSESUARLAR



## Levhali Reklam Dubaları ve Portatif Uyarı Levhaları

ÜRÜN KODU	AÇIKLAMALAR
12429 DB A	levhali reklam dubası - (HxW) 90x49 cm renk: kırmızı / malzeme: PPC / ağırlık: 7.5 kg
12426 DB A	levhali reklam dubası - (HxW) 90x49 cm renk: gri / malzeme: PPC / ağırlık: 7.5 kg
12427 DB A	levhali reklam dubası - (HxW) 90x49 cm renk: sarı / malzeme: PPC / ağırlık: 7.5 kg
12424 DB F A	levhali reklam dubası - (HxW) 90x49 cm - iki yönde uyarı renk:kırmızı / folyo:60x40cm/malzeme:PPC/ağırlık:7.5kg
12421 DB F A	levhali reklam dubası - (HxW) 90x49 cm - iki yönde uyarı renk: sarı / folyo: 60x40 cm / malzeme:PPC/ağırlık:7.5kg
108 A F	portatif uyarı levhası-(HxW) 62x24.5cm - iki yönde uyarı folyo: 27x20 cm / malzeme: ABS / ağırlık: 1.0 kg
107 A	portatif uyarı levhası-(HxW) 62x24.5cm malzeme: ABS / ağırlık: 1.0 kg



12429-12421-12426-12427-12424 DB F A / OPSİYONEL AKS.

\*\* Bu Ürünlerde Farklı Şekil Baskı Seçeneği





12325 TK R2 12327 TK A R2



12393 TK R2 12395 TK A R2

## 90 cm PVC / TPE Trafik Konileri

Prismatic Reflective Sheeting

	ÜRÜN KODU	AÇIKLAMALAR
	12325 TK R2	PVC trafik konisi - (H) 90 cm taban:(⊗) 38.5 cm / malzeme: PVC / ağırlık: 3.6 kg
	12327 TK A R2	PVC trafik konisi - (H) 90 cm taban:(⊗) 48.5 cm / malzeme: PVC / ağırlık: 6.9 kg
	12393 TK R2	TPE trafik konisi - (H) 90 cm taban:(⊗) 38.5 cm / malzeme: TPE / ağırlık: 3.0 kg
	12395 TK A R2	TPE trafik konisi - (H) 90 cm taban:(⊗) 48.5 cm / malzeme: TPE / ağırlık: 6.3 kg

### OPSİYONEL AKSESUARLAR

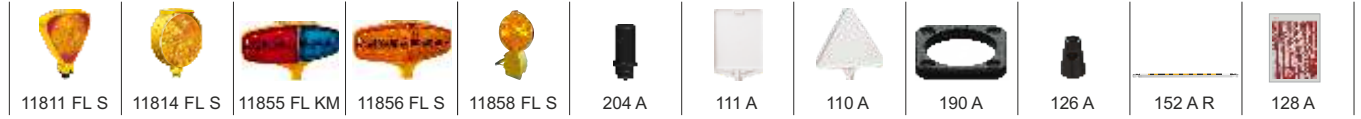

11811 FL S

11814 FL S

11855 FL KM

11856 FL S

11858 FL S

204 A

111 A

110 A

190 A

126 A

152 AR

128 A



12309 TK R2 12315 TK A R2



12387 TK R2 12389 TK A R2

## 75 cm PVC / TPE Trafik Konileri

Prismatic Reflective Sheeting

	ÜRÜN KODU	AÇIKLAMALAR
	12309 TK R2	PVC trafik konisi - (H) 75 cm taban:(⊗) 38.5 cm / malzeme: PVC / ağırlık: 3.2 kg
	12315 TK A R2	PVC trafik konisi - (H) 75 cm taban:(⊗) 48.5 cm / malzeme: PVC / ağırlık: 6.5 kg
	12387 TK R2	TPE trafik konisi - (H) 75 cm taban:(⊗) 38.5 cm / malzeme: TPE / ağırlık: 2.7 kg
	12389 TK A R2	TPE trafik konisi - (H) 75 cm taban:(⊗) 48.5 cm / malzeme: TPE / ağırlık: 6.0 kg



12306 TK R1 12326 TK A R1



12364 TK R1 12384 TK A R1

## 50 cm PVC / TPE Trafik Konileri

Prismatic Reflective Sheeting

	ÜRÜN KODU	AÇIKLAMALAR
	12306 TK R1	PVC trafik konisi - (H) 50 cm taban:(⊗) 28.5 cm / malzeme: PVC / ağırlık: 1.3 kg
	12326 TK A R1	PVC trafik konisi - (H) 50 cm taban:(⊗) 38.5 cm / malzeme: PVC / ağırlık: 2.65 kg
	12364 TK R1	TPE trafik konisi - (H) 50 cm taban:(⊗) 28.5 cm / malzeme: TPE / ağırlık: 1.13 kg
	12384 TK A R1	TPE trafik konisi - (H) 50 cm taban:(⊗) 38.5 cm / malzeme: TPE / ağırlık: 2.5 kg



## 70 / 52 cm PVC / TPE Trafik Konileri

Prismatic Reflective Sheeting

ÜRÜN KODU	AÇIKLAMALAR
12337 TK R2	PVC trafik konisi - (H) 70 cm taban:(Ø) 38 cm / malzeme: PVC / ağırlık: 2.3 kg
12332 TK R2	PVC trafik konisi - (H) 52 cm taban:(Ø) 32 cm / malzeme: PVC / ağırlık: 1.25 kg
12376 TK R2	TPE trafik konisi - (H) 70 cm taban:(Ø) 38 cm / malzeme: TPE / ağırlık: 1.9 kg
12370 TK R2	TPE trafik konisi - (H) 52 cm taban:(Ø) 32 cm / malzeme: TPE / ağırlık: 1.0 kg



12337 TK R2



12332 TK R2



12376 TK R2



12370 TK R2

### OPSİYONEL AKSESUARLAR

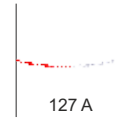

127 A



126 A



196 A



11819 FL S



11817 FL K

## 90 / 50 / 32 cm PVC - 32cm TPE Trafik Konileri

Prismatic Reflective Sheeting

ÜRÜN KODU	AÇIKLAMALAR
12331 TK R2	PVC trafik konisi - (H) 90 cm - reflektif: (Type IV) taban:(Ø) 38.5 cm / malzeme: PVC / ağırlık: 4.0 kg
12318 TK R1	PVC trafik konisi - (H) 50 cm - reflektif: (Type IV) taban:(Ø) 35 cm / malzeme: PVC / ağırlık: 1.8 kg
12316 TK R2	PVC trafik konisi - (H) 50 cm taban:(Ø) 35 cm / malzeme: PVC / ağırlık: 1.7 kg
12303 TK R1	PVC trafik konisi - (H) 32 cm taban:(Ø) 22 cm / malzeme: PVC / ağırlık: 0.65 kg
12362 TK R1	TPE trafik konisi - (H) 32 cm taban:(Ø) 22 cm / malzeme: TPE / ağırlık: 0.54 kg



12331 TK R2



12318 TK R1



12316 TK R2



12303 TK R1



12362 TK R1

## PVC - TPE Trafik Konileri

Uygulama

- \* yüksek performanslı reflektif uyarıcılar
- \* taşıma kancası ve zincir geçirme kanalı
- \* lamba ve levha takılabilme özelliği ile daha etkin uyarı(126 A)
- \* üst üste istiflenebilme özelliği ile minimum hacim
- \* geniş taban alanı sayesinde devrilmeye karşı yüksek stabilite

- \* UV katkılı özel renk karışımı ile parlak görünüm ve uzun ömürlü renk dayanımı
- \* -20°C/+60°C arası sıcaklık direnci
- \* geniş kullanım alanı: yollarda uyarı ve çalışma alanlarında, otoparklarda ve iş güvenliği gerektiren her türlü alanda





11811 FL S  
11813 FL K  
Çift Taraflı LED Işık Kaynağı

11825 FL S  
11827 FL K

## Solar Flaşörlü Ledli Lambalar

ÜRÜN KODU	AÇIKLAMALAR
11811 FL S	solar flaşörlü ledli lamba - (HxW) 30x24 cm - sarı led flaş lens: Ø160 mm / malzeme: ABS / ağırlık: 0.84 kg
11813 FL K	solar flaşörlü ledli lamba - (HxW) 30x24 cm - kırmızı led flaş lens: Ø160 mm / malzeme: ABS / ağırlık: 0.84 kg
11825 FL S	solar flaşörlü ledli lamba - (HxW) 29x22 cm - sarı led flaş lens: Ø160 mm / malzeme: ABS / ağırlık: 0.75 kg
11827 FL K	solar flaşörlü ledli lamba - (HxW) 29x22 cm - kırmızı led flaş lens: Ø160 mm / malzeme: ABS / ağırlık: 0.75 kg

solar panel	tip	ölcü (H/L)	voltaj	watt	malzeme	LED	renk	sarı kırmızı
	monocrystalline silicon cell	45x120 mm	4 V	0.6 W	Ni-MH		ölçü	Ø 5 mm led
							flaş sayısı	105 f/dk
şarjlı pil							uyarı mesafesi	200 m (gece)
							çalışma süresi	gün ışığında şarj ile tüm gece
							çalışma sıcaklığı	-20°C/+60°C



11814 FL S  
11816 FL K  
Çift Taraflı LED Işık Kaynağı

11817 FL K  
11819 FL S  
11821 FL M

## Solar Flaşörlü Ledli Lambalar

ÜRÜN KODU	AÇIKLAMALAR
11814 FL S	solar flaşörlü ledli lamba - (HxW) 27x22 cm - sarı led flaş lens: Ø160 mm / malzeme: ABS / ağırlık: 0.50 kg
11816 FL K	solar flaşörlü ledli lamba - (HxW) 27x22 cm - kırmızı led flaş lens: Ø160 mm / malzeme: ABS / ağırlık: 0.50 kg
11817 FL K	solar flaşörlü ledli lamba-(HxØ)14.5cmx128mm-kırmızı led flaş lens: Ø120 mm / malzeme: PC / ağırlık: 0.35 kg
11819 FL S	solar flaşörlü ledli lamba-(HxØ)14.5cmx128mm-sarı led flaş lens: Ø120 mm / malzeme: PC / ağırlık:0.35 kg
11821 FL M	solar flaşörlü ledli lamba-(HxØ)14.5cmx128mm-mavi led flaş lens: Ø120 mm / malzeme: PC / ağırlık:0.35 kg

ELEKTRONİK DEVRE TEKNİK ÖZELLİKLERİ								
solar panel	tip	ölcü (H/L)	voltaj	watt	malzeme	LED	renk	sarı kırmızı mavi
	monocrystalline silicon cell	45*120-60*54mm	4 V - 3V	0.6 - 0.4 W	Ni-MH		ölçü	Ø 5 mm led
							flaş sayısı	105-115 f/dk
şarjlı pil							uyarı mesafesi	200-100 m(gece)
							çalışma süresi	gün ışığında şarj ile tüm gece
							çalışma sıcaklığı	-20°C/+60°C

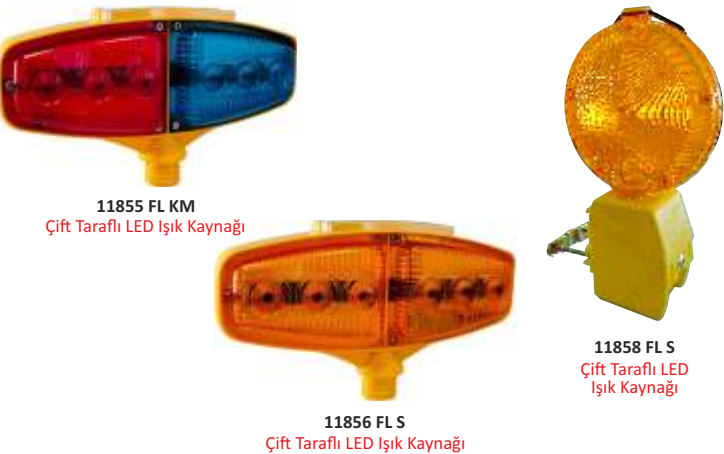

11855 FL KM  
Çift Taraflı LED Işık Kaynağı

11856 FL S  
Çift Taraflı LED Işık Kaynağı

11858 FL S  
Çift Taraflı LED Işık Kaynağı

## Çakar Flaşörlü Solar & Bataryalı Lambalar

ÜRÜN KODU	AÇIKLAMALAR	Vitally®
11855 FL KM	çakar flaşörlü solar lamba-(HxW)17x30cm-kırmızı-mavi led flaş lens: 30x11 cm / malzeme: ABS / ağırlık: 0.46 kg	
11856 FL S	çakar flaşörlü solar lamba - (HxW) 17x30 cm - sarı led flaş lens: 30x11 cm / malzeme: ABS / ağırlık: 0.46 kg	
11858 FL S	bataryalı flaşörlü lamba - (HxW) 32x18 cm - sarı led flaş lens: Ø180 mm / malzeme: ABS / ağırlık: 0.42 kg	

ELEKTRONİK DEVRE TEKNİK ÖZ. - 11855 FL KM / 11856 FL S								
solar panel	tip	ölcü (H/L)	voltaj	watt	malzeme	LED	renk	sarı, kırmızı mavi
	monocrystalline silicon cell	45*120	4 V	0.6 W	Ni-MH		ölçü	Ø 5 mm led
							flaş sayısı	105 f/dk
şarjlı pil							uyarı mesafesi	200-100 m(gece)
							çalışma süresi	gün ışığında şarj ile tüm gece
							çalışma sıcaklığı	-20°C/+60°C

ELEKTRONİK DEVRE TEKNİK ÖZELLİKLERİ - 11858 FL S								
batarya tipi	4R25					LED	renk	sarı
tavsiye edilen kapasite	0.3 W / 6V / 8000 mA/h						ölçü	Ø5 mm x2
işlev	flaş / on-off düğmesi						flaş sayısı	60 f/dk ±%5
montaj	Ø48 or Ø60 mm direkler için						uyarı mesafesi	650-700 m
							çalışma sıcaklığı	-20°C/+60°C

### OPSİYONEL AKSESUARLAR



126 A  
194 A  
184 A  
204 A



## Dubalı Uyarı Dikmeleri

Reflective Engineer Grade

ÜRÜN KODU	AÇIKLAMALAR
12404 DB R	dubalı uyarı dikmesi - (HxØ) 120 cm x 110 mm taban:(Ø)400 mm / malzeme: PPC / ağırlık:12.0 kg
12420 DB R	dubalı uyarı dikmesi - (HxØ) 110 cm x 80 mm taban:(Ø)400 mm / malzeme: PPC / ağırlık: 6.5 kg
12430 DB R	dubalı uyarı dikmesi - (HxØ) 120 cm x 140 mm taban:(Ø) 450 mm / malzeme: PPC / ağırlık: 8.7 kg



12404 DB R



12420 DB R



12430 DB R

### OPSİYONEL AKSESUARLAR



## Dubalı Uyarı Dikmeleri

Reflective Engineer Grade

ÜRÜN KODU	AÇIKLAMALAR
12403-1 DB R	dubalı uyarı dikmesi - (HxØ) 100 cm x 63 mm taban: (Ø)400 mm / malzeme: PPC / ağırlık: 4.0 kg
12409-1 DB R	dubalı uyarı dikmesi - (HxØ) 100 cm x 63 mm taban: (Ø)400 mm / malzeme: PPC / ağırlık: 4.0 kg
12435 DB	dubalı uyarı dikmesi - (HxØ) 90 cm x 40 mm taban: (Ø) 300 mm / malzeme: PE / ağırlık: 1.9 kg



12403-1 DB R



12409-1 DB R



12435 DB

### OPSİYONEL AKSESUARLAR



## Dubalı Uyarı Dikme Uygulamaları

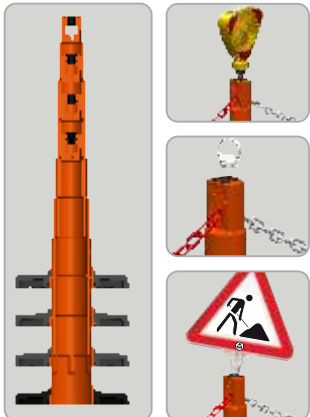

## Kablo ve Hortum Koruyucu Kasis



22218 UB

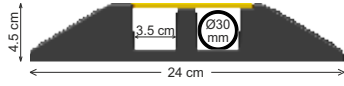

ÜRÜN KODU	AÇIKLAMALAR
22218 UB	kablo koruyucu kasis - ölçü: 24x100x4.5 cm - 2 kanallı malzeme: kauçuk / ağırlık: 7.5 kg



## Kablo ve Hortum Koruyucu Kasis

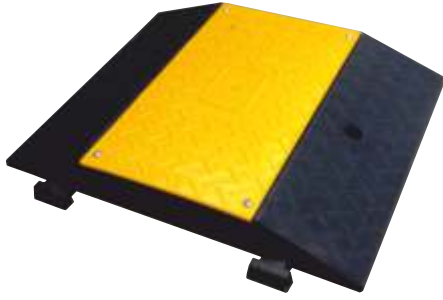

12298 UB



ÜRÜN KODU	AÇIKLAMALAR
12298 UB	kablo koruyucu kasis - ölçü: 60x50x7.5 cm - 3 kanallı montaj: 2x / malzeme: PPC / ağırlık: 8.7 kg
12299 UB	kablo koruyucu kasis köşe - ölçü: 60x7.5 cm - 3 kanallı montaj: 2x / malzeme: PPC / ağırlık: 3.0 kg



12299 UB

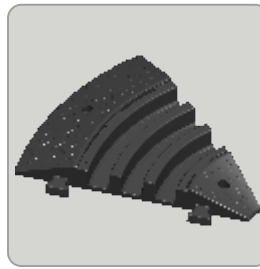

Sürekli Kablo Koruması için Köşe Bağlantı Modülü





## Görme Engelli Zemin İşaretlemeleri

ÜRÜN KODU	AÇIKLAMALAR
PL 8010	görme engelli zemin işaretleme - ölçü: 40x40 cm malzeme: TPU / ağırlık: 0.70 kg
PL 8011	görme engelli zemin işaretleme - ölçü: 40x40 cm malzeme: TPU / ağırlık: 0.70 kg
PL 8012	görme engelli zemin işaretleme - ölçü: 40x40 cm malzeme: TPU / ağırlık: 0.85 kg
PL 8013	görme engelli zemin işaretleme - ölçü: 40x40 cm malzeme: TPU / ağırlık: 0.85 kg
PL 8014	görme engelli zemin işaretleme - ölçü: 60x30 cm malzeme: TPU / ağırlık: 0.77 kg
PL 8015	görme engelli zemin işaretleme - ölçü: 60x30 cm malzeme: TPU / ağırlık: 0.77 kg
PL 8016	görme engelli zemin işaretleme - ölçü: 60x30 cm malzeme: TPU / ağırlık: 0.90 kg
PL 8017	görme engelli zemin işaretleme - ölçü: 60x30 cm malzeme: TPU / ağırlık: 0.90 kg
PL 8018	görme engelli zemin işaretleme - ölçü: 58x58 cm malzeme: TPU / ağırlık: 1.40 kg
PL 8019	görme engelli zemin işaretleme - ölçü: 58x58 cm malzeme: TPU / ağırlık: 1.40 kg

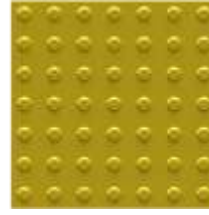
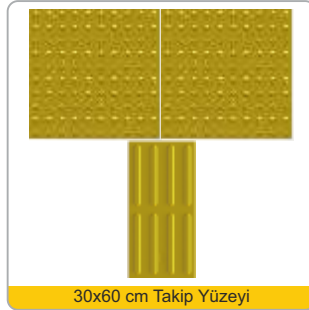
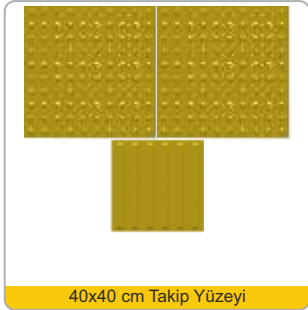

PL 8010

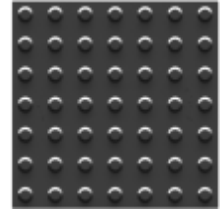

PL 8011



PL 8012



PL 8013

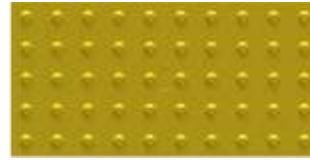

PL 8014



PL 8015



PL 8016



PL 8017

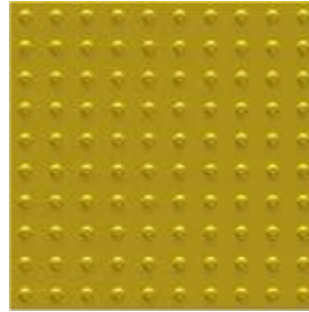

PL 8018



PL 8019

## TPU Merdiven Kaydırmaz Kaplama

ÜRÜN KODU	AÇIKLAMALAR
PL 8020	TPU merdiven kaydırmaz kaplama / butil bantlı ölçü: 60x30 cm / malzeme: TPU / ağırlık: 0.90 kg
PL 8022	TPU merdiven kaydırmaz kaplama / butil bantlı ölçü: 60x30 cm / malzeme: TPU / ağırlık: 0.90 kg

### TPU Merdiven Kaydırmaz Kaplama (Butil Bantlı)

**Ürün Tanımı:** TPU esaslı dış mekân kaydırmaz zemin kaplamamız; yağmur, kar ve don gibi zorlu hava koşullarında kendinden yapışkanlı, yüksek tutunma sağlayan profesyonel bir güvenlik çözümüdür. Yaya güvenliğini artırır, düşme ve yaralanma risklerine karşı ideal bir çözümdür.

### Kullanım Alanları

- Apartman ve site dış merdivenleri
- Okul, hastane ve kamu binaları
- Alışveriş merkezleri ve iş merkezleri
- Fabrika ve depo dış alan merdivenleri
- Otopark ve acil çıkış merdivenleri
- Bahçe, teras ve açık alan merdivenleri



PL 8020



PL 8022

### Montaj ve Uygulama Bilgileri

Merdiven basamağı kuru, temiz ve tozsuz olmalıdır. Ürünün arka yüzeyindeki koruyucu film sökülür. Ürün basamağa dikkatlice yerleştirilir ve tüm yüzeye eşit baskı uygulanarak yapıştırılır. Uygulamadan hemen sonra kullanılabilir. Tam yapışma kısa sürede gerçekleşir.



12276 UB D



12277 UB D

OPSİYONEL AKSESUARLAR

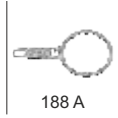

188 A



185 A



175 A



129 A



123 A



12279 UB D



12280 UB D

## Demonte Kaldırım Sınırlama Dubaları

Prismatic Reflective Sheeting

ÜRÜN KODU	AÇIKLAMALAR
12276 UB D	demonte kaldırım sınırlama dubası - (HxØ) 87x8 cm taban:(Ø)110mm/montaj:2x/malzeme:TPU/ağırlık:1.72 kg
12277 UB D	demonte kaldırım sınırlama dubası - (HxØ) 68x8 cm taban:(Ø)110mm/montaj:2x/malzeme:TPU/ağırlık:1.38 kg
12279 UB D	demonte kaldırım sınırlama dubası - (HxØ) 81.5x8 cm taban:(Ø)110mm/montaj:2x/malzeme:TPU/ağırlık:1.62 kg
12280 UB D	demonte kaldırım sınırlama dubası - (HxØ) 62.5x8 cm taban:(Ø)110mm/montaj:2x/malzeme:TPU/ağırlık:1.28 kg



185 A Zincir Aparatı Uygulama



188 A Duba Anahtarı



## Levhali Esnek Refüj Dubaları

Prismatic Reflective Sheeting

ÜRÜN KODU	AÇIKLAMALAR
22026 UB R	levhali esnek refüj dubası-(H)120cm levha ölçü:(Ø)300mm montaj: 2x / malzeme: TPU / ağırlık: 2.1 kg
22028 UB R	levhali esnek refüj dubası-(H)108cm levha ölçü:210x125mm montaj: 2x / malzeme: TPU / ağırlık: 1.9 kg
22032 UB R	levhali esnek refüj dubası-(H)103cm levha ölçü:100x400mm montaj: 2x / malzeme: TPU / ağırlık: 2.0 kg

Opsiyonel Uyarı İşaretleri (Tek Yönlü)

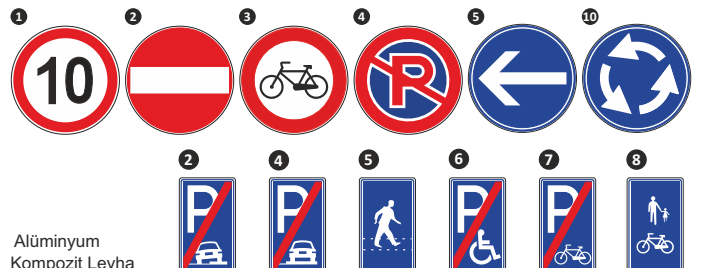

Alüminyum Kompozit Levha



22026 UB R



22028 UB R



22032 UB R



## Kaldırım Sınırlama Dubaları

Reflective Engineer Grade

ÜRÜN KODU	AÇIKLAMALAR
12213 UB R	kaldırım sınırlama dubası - (HxØ) 80x9.0 cm taban:(Ø)200mm/montaj:4x/malzeme:PPC/ağırlık:1.25 kg
12223 UB R	kaldırım sınırlama dubası-(HxØ)50x9.0cm taban:(Ø)200mm/montaj:4x/malzeme:PPC/ağırlık:0.90 kg
22035 UB R	kaldırım sınırlama dubası - (HxØ) 80x9.0 cm taban:(Ø)200mm/montaj:4x/malzeme:PPC/ağırlık:1.25 kg
22031 UB R	kaldırım sınırlama dubası - (HxØ) 50x9.0 cm taban:(Ø)200mm/montaj:4x/malzeme:PPC/ağırlık:0.90 kg



12213 UB R



12223 UB R

## Kaldırım Sınırlama Dubaları

Reflective Engineer Grade

ÜRÜN KODU	AÇIKLAMALAR
12205 UB R	kaldırım sınırlama dubası - (H) 50 cm / taban: 25x25 cm montaj: 4x / malzeme: PE / ağırlık: 1.5 kg
22033 UB R	kaldırım sınırlama dubası - (H) 50 cm / taban: 25x25 cm montaj: 4x / malzeme: PE / ağırlık: 1.5 kg



12205 UB R



22033 UB R

## Anti-Park Dubaları - Metal

ÜRÜN KODU	AÇIKLAMALAR
12293 UB ST	ant-park dubası - (HxØ)61cmx150mm / taban: 20x20 cm montaj: 4x / malzeme: ST / ağırlık: 6.7 kg
12289 UB ST	anti-park dubası - (HxØ)78cmx150mm / taban: 20x20 cm montaj: 4x / malzeme: ST / ağırlık: 8.3 kg

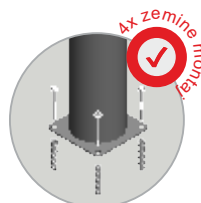
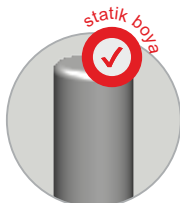

12293 UB ST



12289 UB ST



11800 FL (SERİSİ)  
(60x60 cm)

## Solar Ledli Yol Bakım Levhaları

ÜRÜN KODU	AÇIKLAMALAR
11800 FL (SERİSİ)	solar ledli yol bakım levhaları - (HxW) 90x60 cm led panel: 60x60 cm - gövde malzeme: PC - ağırlık: 9.8 kg

\*\* Bu Ürünlerde Farklı Şekil Uygulama Seçeneği \*\* Reflektifli Kompozit AL Panel



## Solar Ledli Uyarı Levhaları

ÜRÜN KODU	AÇIKLAMALAR
21800 FL (SERİSİ)	solar ledli yol bakım levhaları - (HxW) 90x60 cm led panel: 60x60 cm - gövde malzeme: PC - ağırlık: 9.8 kg

\*\* Bu Ürünlerde Farklı Şekil Uygulama Seçeneği \*\* Reflektifli Kompozit AL Panel



21800 FL (SERİSİ)  
(60x60 cm)

## Ürün Teknik Verileri

ELEKTRONİK DEVRE TEKNİK ÖZELLİKLERİ					
solar panel	tip	glass laminated	renk	sarı kırmızı	
	ölçü (H/W)	293x345 mm	LED	ölçü	Ø5 mm
	voltaj	18 V		flaş sayısı	54 f/dk
	watt	10 W	malzeme	SLA	uyarı mesafesi
lityum pil	voltaj	12 V	çalışma süresi	gün ışığında şarj ile tüm gece	
	akım	6000 mA/h	çalışma sıcaklığı	-20°C/+60°C	



Solar Ledli Bilgi Levhaları, özel tasarlanmış kelepçe ile omega ve Ø5.0 ile Ø7.5 cm boru direklere kolayca montajlanır, montaj kelepçesi sayesinde yukarı aşağı hareketi ayarlanır.





## Güvenlik Barikati

Reflective Engineer Grade

ÜRÜN KODU	AÇIKLAMALAR
12511 FB R	güvenlik barikati - (HxL) 100x150 cm malzeme: PPC / ağırlık: 10.5 kg

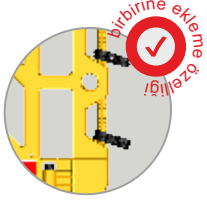

birbirine ekeme  
özelliği



üstte istiflene  
imkanı



opsiyonel aksesuarlar  
soket



90° dönen ayak  
kaydırma  
kolaylığı



120 A



204 A



11817 FL K



11858 FL S



11814 FL S



11811 FL S



11856 FL S

### OPSİYONEL AKSESUARLAR

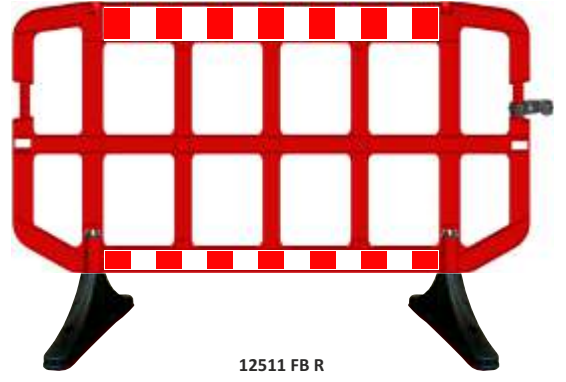

12511 FB R

## Güvenlik Barikatları

Reflective Engineer Grade

ÜRÜN KODU	AÇIKLAMALAR
12510 FB R	güvenlik barikati - (HxL) 100x150 cm renk: kırmızı / malzeme: PPC / ağırlık: 12.0 kg
12514 FB R	güvenlik barikati - (HxL) 100x150 cm renk: sarı / malzeme: PPC / ağırlık: 12.0 kg
12518 FB R	güvenlik barikati - (HxL) 100x150 cm renk: beyaz / malzeme: PPC / ağırlık: 12.0 kg
12516 FB R	güvenlik barikati - (HxL) 100x150 cm renk: mavi / malzeme: PPC / ağırlık: 12.0 kg



110 A



204 A



11858 FL S



11825 FL S



11814 FL S



11811 FL S



11856 FL S

### OPSİYONEL AKSESUARLAR



12510 FB R

## Levhalı Güvenlik Barikatlar

Reflective Engineer Grade

ÜRÜN KODU	AÇIKLAMALAR
12517 FB R	levhalı güvenlik barikati - (HxL) 100x150 cm levha: 100x50 cm / malzeme:PPC / ağırlık:12.3 kg
12513 FB R	levhalı güvenlik barikati - (HxL) 100x150 cm levha: 100x50 cm / malzeme:PPC / ağırlık:12.3 kg

\*\* Bu Ürünlerde Farklı Şekil Baskı Seçeneği



Opsiyonel Uyarı İşaretleri (Tek Yönlü)

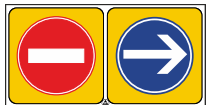

Şekil 1



Şekil 2



Şekil 3

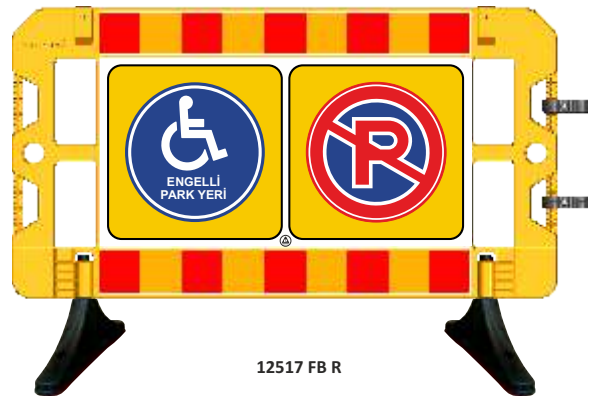

12517 FB R

### OPSİYONEL AKSESUARLAR



204 A

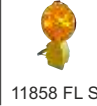

11858 FL S



11816 FL K



11825 FL S



11811 FL S



11856 FL S



12405 DB R

OPSİYONEL AKSESUARLAR



**Dubalı Uyarı Levhalı Bariyer**  
Reflective Engineer Grade

ÜRÜN KODU	AÇIKLAMALAR
12405 DB R	dubalı uyarı levhalı bariyer - (HxL) 120x180 cm levha: 75x125 cm / malzeme: PPC / ağırlık: 31.0 kg

\*\* Bu Ürünlerde Farklı Şekil Baskı Seçeneği



Şekil 1

Şekil 2

Şekil 3

Opsiyonel Uyarı İşaretleri (Tek Yönlü)

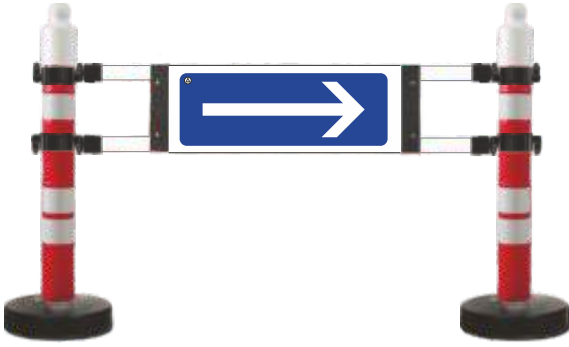

12407 DB R

OPSİYONEL AKSESUARLAR



**Dubalı Uyarı Levhalı Bariyer**  
Reflective Engineer Grade

ÜRÜN KODU	AÇIKLAMALAR
12407 DB R	dubalı uyarı levhalı bariyer - (HxL) 120x180 cm levha: 31.5x90 cm / malzeme: PPC / ağırlık:27.0 kg

\*\* Bu Ürünlerde Farklı Şekil Baskı Seçeneği



Şekil 1

Şekil 2

Şekil 3

Opsiyonel Uyarı İşaretleri (Tek Yönlü)

**Dubalı Uyarı Levhalı Bariyer Uygulamaları**





## Solar Ledli Flaşör Uyarı Lambaları ve Uyarı Levhaları

ÜRÜN KODU	AÇIKLAMALAR
11851 FL S	solar ledli siperlikli flaşör lamba - (HxW) 70x40cm-sarı led flaş lens: Ø300 mm / malzeme: PC / ağırlık: 8.0 kg
11853 FL K	solar ledli siperlikli flaşör lamba-(HxW)70x40cm-kırmızı led flaş lens: Ø300 mm / malzeme: PC / ağırlık: 8.0 kg
11850 FL S	solar ledli flaşör uyarı lambası - (HxW) 70x40cm - sarı led flaş lens: Ø300 mm / malzeme: PC / ağırlık: 7.3 kg
11852 FL K	solar ledli flaşör uyarı lambası - (HxW) 70x40cm-kırmızı led flaş lens: Ø300 mm / malzeme: PC / ağırlık: 7.3 kg
11862 FL S	solar ledli uyarı levhası - (HxW) 70x40 cm - sarı led led panel: 40x40 cm / malzeme: PC / ağırlık: 7.0 kg
11860 FL S	solar ledli uyarı levhası - (HxW) 70x40 cm - sarı led led panel: 40x40 cm / malzeme: PC / ağırlık: 7.0 kg

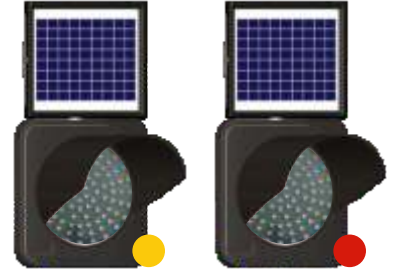

11851 FL S

11853 FL K



11850 FL S

11852 FL K

11862 FL S

11860 FL S

## AC Ledli Lambalar ve Yol Bakım Levhaları

ÜRÜN KODU	AÇIKLAMALAR
11882 FL A	AC ledli levha - (HxW) 40x40 cm - sarı led led panel: 40x40 cm / malzeme: PC / ağırlık: 2.8 kg
11883 FL A	AC ledli levha - (HxW) 40x40 cm - sarı led led panel: 40x40 cm / malzeme: PC / ağırlık: 2.8 kg
11885 FL A	ledli lamba - (HxW) 40x40 cm - sarı led flaş lens: Ø300 mm / malzeme: PC / ağırlık: 3.1 kg
11884 FL A	
11888 FL A	AC ledli yol bakım levhaları - (HxW) 60x60 cm
11889 FL A	led panel: 60x60 cm
11886 FL A	malzeme: PC - ağırlık: 5.5 kg
11890 FL A	

11882 FL A  
(Sağdan Gidiniz)

11885 FL A



11884 FL A

11888 FL A  
(Sağdan Gidiniz)

11886 FL A



11890 FL A

## Ürün Teknik Verileri

ELEKTRONİK DEVRE TEKNİK ÖZELLİKLERİ - (Solar)				
solar panel	tip	glass laminated	renk	sarı kırmızı
	ölçü (H/L)	293x345 mm	ölçü	Ø10-Ø5 mm
	voltaj	18 V	flaş sayısı	65 f/dk
lityum pil	watt	10 W	uyarı mesafesi	500 m (gece)
	malzeme	SLA	çalışma süresi	gün ışığında sarı ile tüm gece
	voltaj	12 V	çalışma sıcaklığı	-20°C/+60°C
akım	6000 mA/h			

ELEKTRONİK DEVRE TEKNİK ÖZELLİKLERİ - (AC)				
voltaj	12 V AC	LED	renk	sarı kırmızı beyaz
	220 V AC		ölçü	Ø10-Ø5 mm
			flaş sayısı	65-54 f/dk
			uyarı mesafesi	500 m (gece)
			çalışma sıcaklığı	-20°C/+60°C



Solar Ledli Bilgi Levhaları, özel tasarlanmış kelepçe ile omega ve Ø5.0 ile Ø7.5 cm boru direklere kolayca montajlanır, montaj kelepçesi sayesinde yukarı aşağı hareketi ayarlanır.

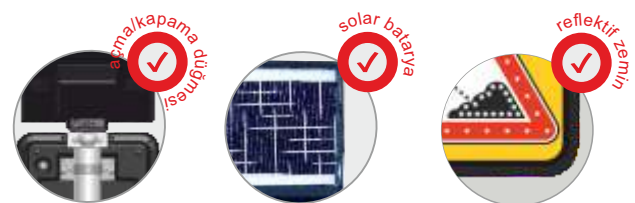



12500 FB R



Opsiyonel Uyarı İşaretleri (Tek Yönlü)

OPSİYONEL AKSESUARLAR



**Katlanır Uyarı Levhalı Bariyer**  
Reflective Engineer Grade

ÜRÜN KODU	AÇIKLAMALAR
12500 FB R	katlanır uyarı levhalı bariyer - (HxW) 150x110 cm levha: 90x90 cm / malzeme: PPC / ağırlık: 18.0 kg

\*\* Bu Ürünlerde Farklı Şekil Baskı Seçeneği



**Katlanır Uyarı Levhalı Bariyer**  
Reflective Engineer Grade

ÜRÜN KODU	AÇIKLAMALAR
12501 FB R	katlanır uyarı levhalı bariyer - (HxW) 90x115 cm levha: 30x90 cm / malzeme: PPC / ağırlık: 20.0 kg
12503 FB R	katlanır uyarı levhalı bariyer- (HxW) 110x55 cm levha: 90x30 cm / malzeme: PPC / ağırlık: 15.5 kg

\*\* Bu Ürünlerde Farklı Şekil Baskı Seçeneği



12501 FB R



12503 FB R

OPSİYONEL AKSESUARLAR



**Katlanır Uyarı Levhalı Bariyer**  
Reflective Engineer Grade

ÜRÜN KODU	AÇIKLAMALAR
12504 FB R	katlanır uyarı levhalı bariyer - (HxW) 110x250 cm levha: 125x75 cm / malzeme: PPC / ağırlık: 37.0 kg

\*\* Bu Ürünlerde Farklı Şekil Baskı Seçeneği

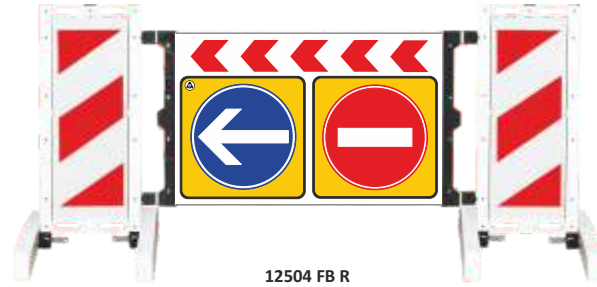

12504 FB R

Opsiyonel Uyarı İşaretleri (Tek Yönlü)



Şekil 1

Şekil 2

Şekil 3

OPSİYONEL AKSESUARLAR





## Solar Ledli Yol Bakım Levhaları

ÜRÜN KODU	AÇIKLAMALAR
11600 S-LD (SERİSİ)	solar ledli yol bakım levhaları - (HxW) 90x60 cm led panel: 60x60 cm - gövde malzeme: AL - ağırlık: 9.7 kg
11700 S-LD (SERİSİ)	solar ledli yol bakım levhaları - (HxW) 130x100 cm led panel: 100x100cm - gövde malzeme: AL - ağırlık: 16.5kg

\*\* Bu Ürünlerde Farklı Şekil Uygulama Seçeneği \*\* Reflektifli Kompozit AL Panel

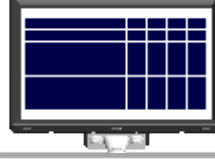

11700 S-LD (SERİSİ)  
(100x100 cm)

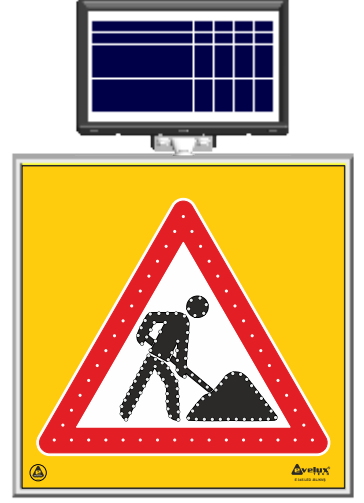

11600 S-LD (SERİSİ)  
(60x60 cm)

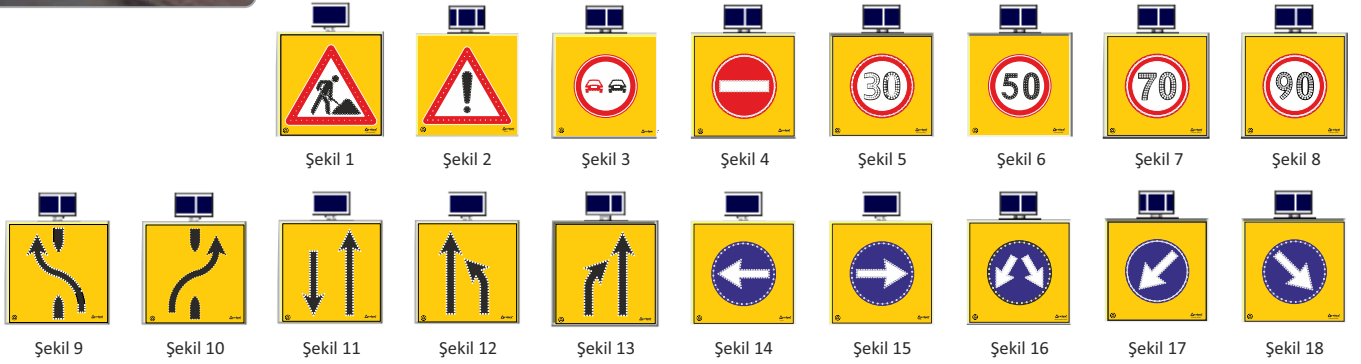

## Solar Ledli Yol Bakım Levhaları

ÜRÜN KODU	AÇIKLAMALAR
11750 S-LD	solar ledli yol bakım levhası - (HxW) 80x150 cm led panel: 50x150cm - gövde malzeme: AL - ağırlık: 14.0kg
11778 S-LD	solar ledli yol bakım levhası - (HxW) 130x100 cm led panel: 100x100cm - gövde malzeme: AL - ağırlık:16.5kg

\*\* Bu Ürünlerde Farklı Şekil Uygulama Seçeneği \*\* Reflektifli Kompozit AL Panel



11750 S-LD  
(50x150 cm)



11778 S-LD  
(100x100 cm)

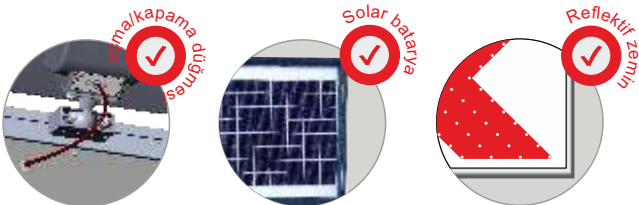



12520 FB R

12526 FB R



## Güvenlik Bariyerleri (Kedi Gözlü ve Solar) Reflective Engineer Grade

ÜRÜN KODU	AÇIKLAMALAR
12520 FB R	kedi gözlü güvenlik bariyeri - (HxLxW) 60x100x40 cm malzeme: PPC / ağırlık: 20.0 kg
12526 FB R	solar flaşörlü güvenlik bariyeri -(HxLxW) 60x100x40 cm lens ölçüsü: (Ø) 100 mm / malzeme:PPC / ağırlık: 20.0kg



## Güvenlik Bariyerleri (Delinatörlü ve Levhalı) Reflective High Intensity Grade

ÜRÜN KODU	AÇIKLAMALAR
12524 FB R	delinatörlü güvenlik bariyeri - (HxLxW) 100x100x40 cm del.:(HxØ)40 cmx80 mm / malzeme:PPC / ağırlık:20.0 kg
12522 FB R	levhalı güvenlik bariyeri - (HxLxW) 120x100x40 cm reflektif:(HxW) 50x12 cm / malzeme:PPC / ağırlık:20.0 kg



12524 FB R

12522 FB R

Levha Ölçü: 57.5x13 cm - Reflective High Intensity Grade



Şekil 1

Şekil 2

Şekil 3

Şekil 4

Şekil 5

Opsiyonel Uyarı İşaretleri (Tek Yönlü)

## Metal Güvenlik Bariyatı

ÜRÜN KODU	AÇIKLAMALAR
12534 FB ST	metal güvenlik bariyatı - (HxL) 110x200 cm malzeme:metal-Ø32x2mm yuvarlak boru / ağırlık:15.0 kg

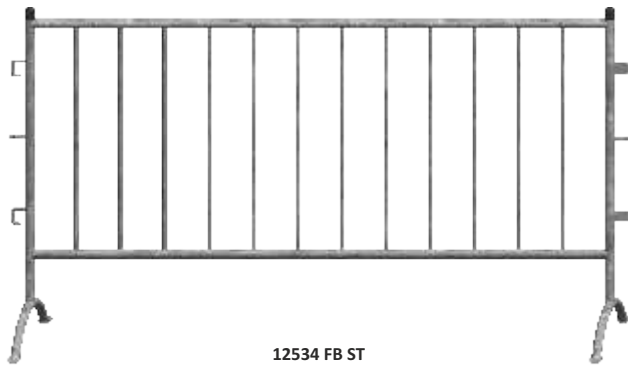

12534 FB ST

### Kalabalık Bariyeri

Etkinlik alanlarının bariyeri ve güvenliği olarak çok yönlü uygulama, Ø 32 mm yuvarlak borudan kaynaklı statik boyalı yapı, çeşitli elemanları birleştirmek için yanlara kaynaklanmış kancalar ve bağlantı braketleri, iki ayak bükülmüş yuvarlak boru bariyerin stabilitesini sağlar, toplam yükseklik: 1.10 m, Ø 16 mm yuvarlak borudan oluşan sağlam dikey çubuklar güvenli bariyer etkisi sağlar





## Levhali Uyarı Dubaları & Katlanır Uyarı Levhali Bariyer

Reflective Engineer Grade

ÜRÜN KODU	AÇIKLAMALAR
12423 DB R A	levhali uyarı dubası - (HxW) 90x49 cm reflektif: 60x40 cm / malzeme: PPC / ağırlık: 7.5 kg
12417 DB R	katlanır uyarı levhali bariyer - (HxW) 90x60 cm levha: 60x60 cm / malzeme: PPC / ağırlık: 12.0 kg

\*\* Bu Ürünlerde Farklı Şekil Baskı Seçeneği

Opsiyonel Uyarı İşaretleri (Tek Yönlü)



12423 DB R A  
(Tek Yönde Uyarı)



12417 DB R

OPSİYONEL AKSESUARLAR



## Katlanır ve Otoyol Uyarı Levhaları

Reflective Engineer Grade

ÜRÜN KODU	AÇIKLAMALAR
12410 DB R	katlanır uyarı levhası - (H) 120 cm / taban: 31x48 cm reflektif: 100x25 cm / malzeme: PPC / ağırlık: 12.0 kg
12415 DB R	katlanır uyarı levhası - (H) 104 cm / taban: 31x48 cm reflektif: 80x20 cm / malzeme: PPC / ağırlık: 11.0 kg
12416 DB R	katlanır uyarı levhası - (H) 72 cm / taban: 22x45 cm reflektif: 48x20 cm / malzeme: PPC / ağırlık: 6.5 kg
12442 DB R	otoyol uyarı levhası-(H)132cm/malzeme:PPC/ağırlık:2.1kg reflektif: 100x25cm / EN 12899-1 RA1
12444 DB R	otoyol uyarı levhası-(H)132cm/malzeme:PPC/ağırlık:2.1kg reflektif: 100x25cm / EN 12899-1 RA1

\*\* Bu Ürünlerde Farklı Şekil Baskı Seçeneği



12410 DB R

12415 DB R

12416 DB R



Esnek ve Dayanıklı Dizayn

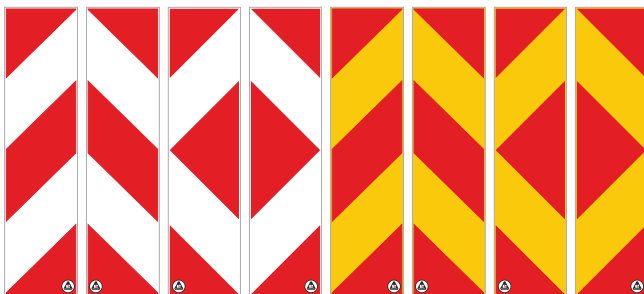

Opsiyonel Uyarı İşaretleri  
12410 DB R - 12415 DB R - 12416 DB R - 12442 DB R - 12444 DB R

Opsiyonel Kullanım

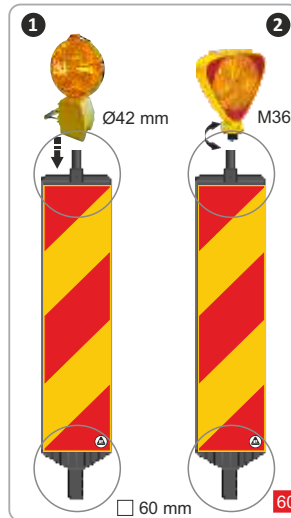

İki Yönde Uyarı



12442 DB R



12444 DB R

İki Yönde Uyarı

OPSİYONEL AKSESUARLAR



## Plastik Uyarı Levhaları Reflective Engineer Grade



111 A



Şekil 1



Şekil 2



Şekil 3



Şekil 4



Şekil 5



Şekil 6



Şekil 7



196 A



Şekil 1



Şekil 2



Şekil 3



Şekil 4



Şekil 5



222 A R



110 A



Şekil 1



Şekil 2



Şekil 3



114 A



120 A



295 A F



124 A F

ÜRÜN KODU	AÇIKLAMALAR
111 A	dikdörtgen uyarı levhası - ölçü: 40x34 cm
196 A	yuvarlak uyarı levhası - ölçü: Ø370 mm
222 A R	yuvarlak uyarı levhası - reflektif ölçü: Ø370 mm iki yönlü uyarı
110 A	üçgen uyarı levhası - ölçü: 50 cm
114 A	uyarı levhası - ölçü: 34x31 cm
120 A	yuvarlak uyarı levhası - ölçü: Ø270 mm
295 A F	yuvarlak uyarı levhası - folyo ölçü: Ø370 mm iki yönlü uyarı
124 A F	yuvarlak uyarı levhası - folyo ölçü: Ø270 mm iki yönlü uyarı

\*\* Bu Ürünlerde Farklı Şekil Baskı Seçeneği



ETR 5111

ETR 5112

ETR 5121

ETR 5122

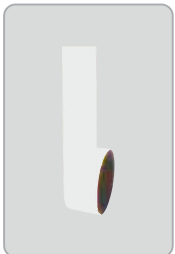

ETR 5131

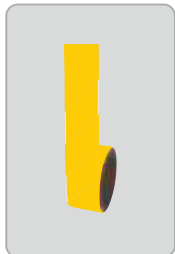

ETR 5141

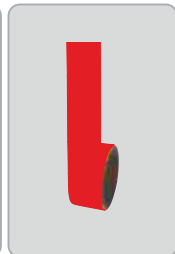

ETR 5151

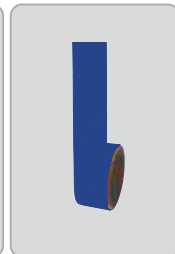

ETR 5161

## Reflektif Bantlar

ÜRÜN KODU	AÇIKLAMALAR
ETR 5111	reflektif bant - 5 cmx10 m/roll - kırmızı - beyaz
ETR 5112	reflektif bant - 10 cmx10 m/roll - kırmızı - beyaz
ETR 5121	reflektif bant - 5 cmx10 m/roll - sarı - siyah
ETR 5122	reflektif bant - 10 cmx10 m/roll - sarı - siyah
ETR 5131	reflektif bant - 5 cmx11 m/roll - beyaz
ETR 5141	reflektif bant - 5 cmx11 m/roll - sarı
ETR 5151	reflektif bant - 5 cmx11 m/roll - kırmızı
ETR 5161	reflektif bant - 5 cmx11 m/roll - mavi

## Ürün Montaj Adaptörleri ve Plastik Zincirler

ÜRÜN KODU	AÇIKLAMALAR
194 A	delinatör aparatı - (Ø) 80 mm
126 A	koni aparatı - (H) 10.5 cm
184 A	otoyol levha lamba aparatı - (Ø) 40mm
204 A	bataryalı lamba aparatı - (H) 11 cm
174 A	yivli zincir aparatı - Ø40 mm
185 A	demonte zincir aparatı - (Ø) 85 mm
188 A	demonte duba anahtarı - (ØxH) 110mm x 0.3 cm
175 A	zincir klipsi - Ø8 mm
127 A	8 mm zincir - 3 m - kırmızı-beyaz
123 A	8 mm zincir - 3 m - sarı-siyah
190 A	PVC koni ağırlığı - ölçü: 38.5x38.5x5.0 cm - 5 kg
128 A	8 mm zincir - 25 m pk - kırmızı-beyaz
129 A	8 mm zincir - 25 m pk - sarı-siyah
152 A R	koni ve dikme barikat profili - (L) 150 cm

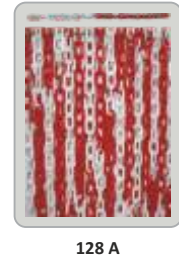

## Vida / Dübel / Çivi

ÜRÜN KODU	AÇIKLAMALAR
159 A	flanşlı trifon vida ve dübel - Ø16x90-Ø10x100mm
160 A	buldex vida ve dübel - Ø14x70 - Ø7.5x80 mm
176 A	flanşlı trifon vida - Ø10x100 mm
161 A	burgulu çivi - Ø5.5x105 mm
173 A	dübel - Ø14x70xØ8mm
172 A	dübel - Ø16x90xØ10mm







## 1- TAVSİYE

Daha düzenli ve güvenli otoparklar oluşturmak için Parxis sizin işlerinizi kolaylaştırır. Bayiniz daha geniş bilgi almanız için size yardımcı olacaktır.

## 2- BELGELENDİRME

YÜKSELEN METAL TS EN ISO 9001:2015'e ve ISO 14001:2015'e göre belgelendirilmiştir. Belgelendirme ürün kalitesi için istenilen çok çeşitli adımlara göre yapılmıştır. Dahası şirket içi işleyiş prosedürlerini geliştirmek için çalışanların sürekli eğitimini ve müşterilerimizle olan ilişkilerini güçlendirmeyi kapsar. Size en yüksek seviyedeki hizmeti sağlayabilmek bizim başarımızdır.

## 3- KATALOGLAR

Belediye otopark birimleri özel otopark işletmeleri, site, AVM alanı ve özel otopark sahipleri ürün seçimi için özel broşür sunuyoruz. Lütfen online olarak görüntüleyiniz.

## 4- WEB SİTE

Web sayfamızı ziyaret ederek daha geniş ürün teknik özelliklerini ve uygulama resimlerinden daha kapsamlı fikir edinebilirsiniz. Görserlerdeki tüm ölçüler teknik çizim değerleridir. Gerçek ürün üzerinden kontrolü sağlayınız.  
[parxis.com.tr](http://parxis.com.tr)

**parxis®**  
OTOPARK DÜZENLEME ÜRÜNLERİ

### Merkez / Mağaza

Şerifali Mah. Mevdudi Sk. No:33/35  
Ümraniye 34775 İSTANBUL/TÜRKİYE  
☎ +90 216 755 30 75  
✉ [satis@parxis.com.tr](mailto:satis@parxis.com.tr)  
🌐 [www.parxis.com.tr](http://www.parxis.com.tr)

### EVELUX

Trafik Güvenlik Sis. Tic. A.Ş.  
Marmara Bölge Müdürlüğü



TS EN ISO 9001:2015



TS EN 13422+A1



14001:2015



CE 200605

## Ürün Kataloğu - 2026

Katalogdaki tüm ürünler Yükselen Metal Kalıp Plastik ve Mak.San. Tic.Ltd.Şti. Ar&Ge departmanında geliştirilmiştir. Tasarımlar patentlidir. Devam eden ürün geliştirme programı nedeniyle, hammaddelerin belirli bir özelliğinden dolayı oluşabilecek toleranslara tabi olan özelliklerde, ekipmanda ve ürün/model kullanılabilirliğinde değişiklik yapma hakkı saklıdır. Parxis Evelux'ün Ürün Pazarlama Markasıdır.



parxis.com.tr



Yetkili Bayi



Katalog No: 2025 / 2 P 04.26